

Mounting instructions for horizontal bar „supra 2“ Robinia

Item No. 55 1515 602

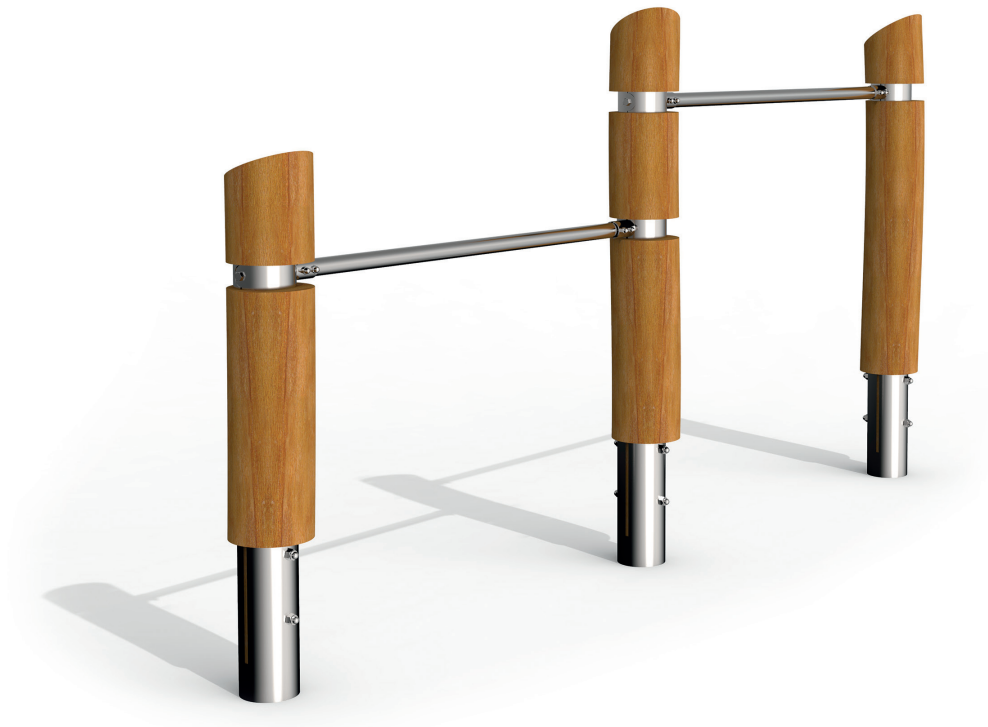
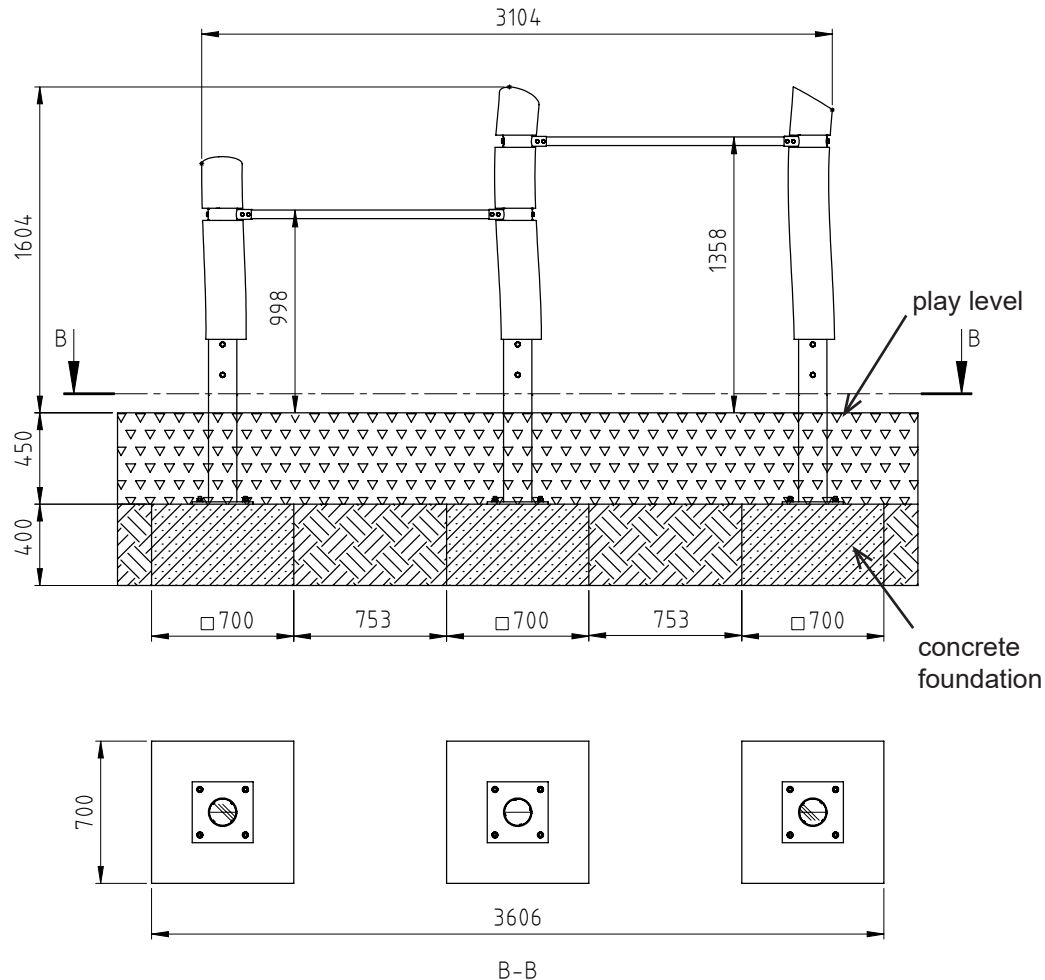

Diagram 1: Overall view of the play equipment

Mounting instructions for horizontal bar „supra 2“ Robinia

Item No. 55 1515 602



Legende



-  stoßdämpfender Boden
shock-absorbing floor
-  Beton
concrete
-  gewachsenes Erdreich
natural ground

Diagram 2: Foundation plan

1. Select the location of the play equipment taking into account the required minimum space (see diagram 4).
2. Carry out excavation work for the foundations as shown in diagram 2. After excavation compress the foundation floor.
Note: The horizontal bar is installed at play level. Pay attention to items marked „play level“ at play equipment!
3. Set up the concrete foundations according to diagram 2 with central, horizontal reinforcement.

Reinforcement plan: Concrete foundation with reinforcement

Foundation: BSt 500S

Stirrups Ø 8 mm lengthwise and cross

Concrete cover $h' = 3$ cm

Concrete quality class C20/25

4. After a setting period of 10 – 14 days, depending on weather conditions and foundation size, fill up and compress the holes between the foundation and the foundation hole with excavation.
5. Clean the foundation surface, place the posts on it and align them. Fix the horizontal bars (see diagram 3) with the clamps using the screws and nuts included in the delivery.
6. Align the play equipment once more on the foundation and screw the play equipment onto the foundation using the included heavy-duty dowels.
7. Cover the entire impact area with fall protection according to the required drop height in accordance with EN 1176-1.

Critical drop height: 1350mm

Recommended surface material: sand, wood chip, gravel, synth. impact protection.

With a smaller installation depth (special edition) we recommend synthetic impact protection. In this case, make sure that protruding parts (e.g. screws, gusset plates) are covered with appropriate fall protection.

Mounting instructions for horizontal bar „supra 2“ Robinia

Item No. 55 1515 602

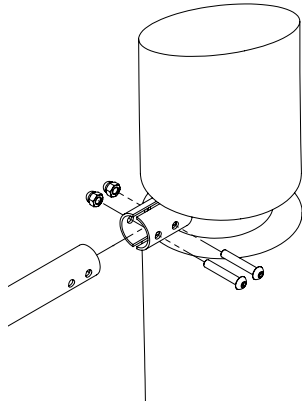

Diagram 3: Assembly

8. Foundations of one-mast equipment have to be accessible for regularly inspection.
9. Do not allow to use the equipment before the installation has been finished.

Attention: If the play equipment has been incompletely installed or partly dismantled when carrying out maintenance and repair work, this may lead to particular risks of injury for the user. For this reason, make clearly visible that the equipment shall not be used in such cases.

STAINLESS STEEL

NOTE: Play equipment, which contain components made of stainless steel should not come with „normal“ steel parts in contact. Those steel parts may rub off and leave small steel particles in combination with moisture brown rust stains.

MAINTENANCE: If such corrosion occur on stainless steel parts, they are fine to remove with an abrasive (240 grit).

Please take care when transporting and setting up the fact that the components are made of stainless steel with no „normal“ steel parts in contact.

In order to preserve a good visual appearance of your stilum playground equipment over a long period one should take care of maintenance of the stainless surface even despite of their corrosion resistance.

Especially areas, which can not be reached by rainfall should be frequently cleaned from dirt and deposits due to air pollution and dirt caused by the atmosphere. Light soiling can easily be removed by using a high pressure cleaner.

For persistent deposits use a clean cloth moistened with a special liquid cleaner (e.g. on phosphoric acid) and rinse off with clear water after a short application time. During cleaning with mild abrasive components, only wipe over stainless steel surface in polishing direction.

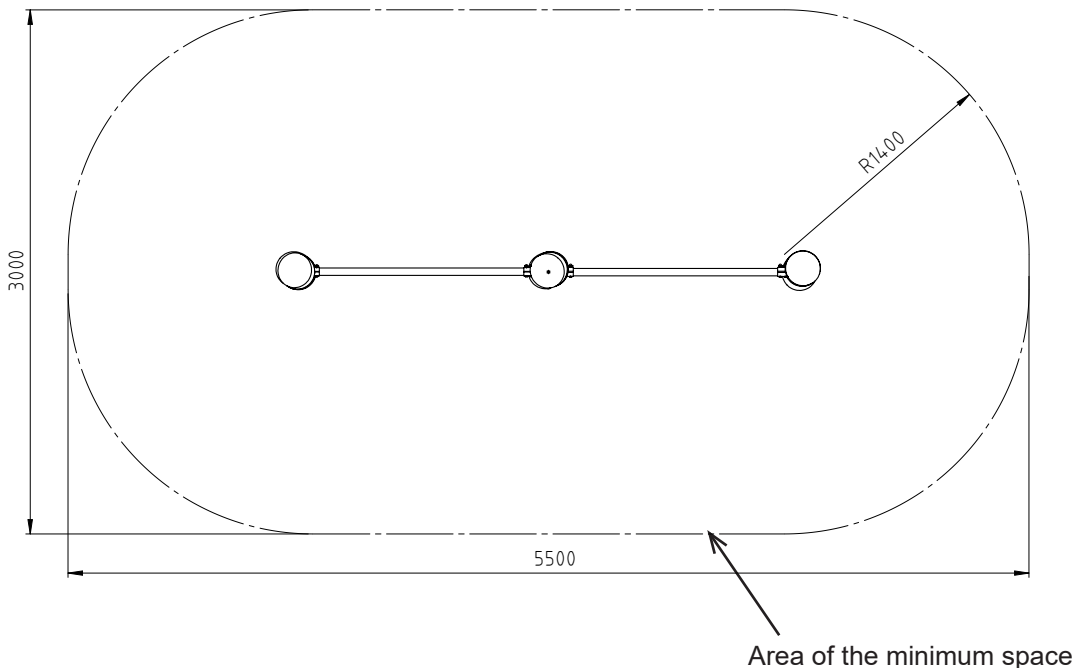

Diagram 4: Top view

Mounting instructions for horizontal bar „supra 2“ Robinia



Item No. 55 1515 602

For heavily soiled surfaces, polishes can be used (e.g. for cleaning chrome on cars) or for greasy and oily dirt alcoholic cleaning agents and solvents (e.g. ethyl alcohol, isopropyl alcohol or acetone).

However, it should be noted that the dissolved soiling is not spread over the surface again.

Do not use any chlorid or hydrochloric containing cleaning products nor scouring powder, bleaching - or silver polish cleaner. Cleaning intervals depend on type and degree of soiling as well as on demands made on optical characteristics.

Therefore cleaning is advisable at intervals of six to twelve months – whereby in the case of strong soiling it is appropriate to clean the playground equipment at intervals of three to six months.

WOOD

NOTE: For all play equipment with wooden elements, it cannot be ruled out that dry cracks may develop. These natural changes of wood are dependent on climate conditions as well as on the age and usage of the play equipment. Longer dry periods may lead to more dry cracks.

This development, however, does not represent a quality defect. Static properties of the equipment are not impaired.

See EN 1176 Bbl 1:2019-01 4.2.7.6: Dry cracks in wood elements as a consequence of weather conditions are not to be considered as dangerous openings in terms of the standard due to the fact that the shape of the cracks (tapering towards the inside) makes it almost impossible for fingers to get trapped in them.

MAINTENANCE: To ensure a long life of stilum playground equipment, wooden surfaces should be regularly re-glazed. This provides the wooden surfaces with the necessary protection and preserves the look. Areas which are not exposed to rain should be regularly freed from deposits.

The cleaning intervals depend on the degree and type of soiling as well as on the exigencies on cleanliness. It is recommended to clean and / or glaze at every 6 to 12 months, or to shorten the cleaning interval to 3 to 6 months if the weather conditions are bad.

LASUR: Use a soft and flat brush or / and a glaze application roll to paint.

The wood should be cleaned a few hours before glazing. That can be done with mild javel water, which should in any case be rubbed off afterwards. For resistant dirt use a wood cleaner. Eventually a light abrasion is necessary. If water-based detergents are used for cleaning, please ensure that the wood elements are thoroughly dried before the glazing is done.

Always brush in one direction, so that the glaze can spread evenly. Apply very thinly!

Remove glaze with a soft cotton cloth.

Then let the freshly glazed wood dry for at least one day and prohibit the use of the equipment for this duration.